

iGas Detector CO₂

Portable Single Gas Detector



User's Manual

SENKO

Product Overview

The iGas Detector CO₂ is a portable single gas detector designed to detect the presence of carbon dioxide gas in ambient environment. When activated, iGas Detector CO₂ continuously monitors ambient air for the presence of carbon dioxide gas and alerts the user to potentially unsafe exposure with LED, vibrating, and audible alarms in the event that gas concentration exceeds alarm setpoints. The settings value can be adjusted manually or by connecting to a PC software.

WARNING

- Any unauthorized attempt to repair or modify the product, or any other cause of damage beyond the range of the intended use, including damage by fire, lightning, or other hazard, voids liability of the manufacturer.
- Activate this product only if sensor, visual, detection, and audible cover are clear from contaminants such as dirt and debris that could block the area where gas is to be detected.
- Do not clean and rub the LCD screen of the products with a dry cloth or hands in hazardous environment to prevent the static electricity.
- Perform cleaning and maintenance of the products in fresh air that is free of hazardous gases
- Test the response of a sensor regularly by the gas concentration exceeding alarm set points.
- Test LED, audio and vibration manually.
- If the temperature changes sharply during use of the device (e.g., indoors vs outdoors), the value of the measured gas concentration can suddenly change. Please use the detector after the gas concentration value has stabilized.
- Severe vibration or shock to the device may cause a sudden reading change. Please use detector after the value of gas concentration has stabilized. Excessive shock to the detector can cause the device and/or sensor to malfunction.
- Alarm value should be set based on the international standard. Therefore, alarm values should be changed only under the responsibility and approval of the administration of the work site where the instrument is used.
- Replace the battery and sensor in clean environment, which is free of hazardous gas.
- If the CO₂ concentration reaches 0ppm, the calibration should be performed.

CAUTION

- Before operating this device, please read the manual carefully.
- This device is not an analyzer, but a gas detector.
- If calibration and self-test fails continuously, please do not use the device.
- Clean detectors with a soft cloth and do not use chemical substances for cleaning.

Table Contents

1. LCD and Part Description	4
2. Activation & Deactivation	5
2.1. Bump test	
3. Mode	6
3.1. Measuring Mode	
3.2. Display Mode	
3.3. Menu Tree	7
4. Setting Mode	8
4.1. Alarm & Adjust alarm setpoints	9
4.2. Calibration	10
4.3. Clr max	11
4.4. Clr STEL and TWA	12
4.5. Adjust Unit	
4.6. Factory Reset	
4.7. Self Test	
5. Software Manager	13
6. Maintenance	16
7. Specification	18
8. Battery Charging	18
9. Warranty	19

1. LCD and Part Description

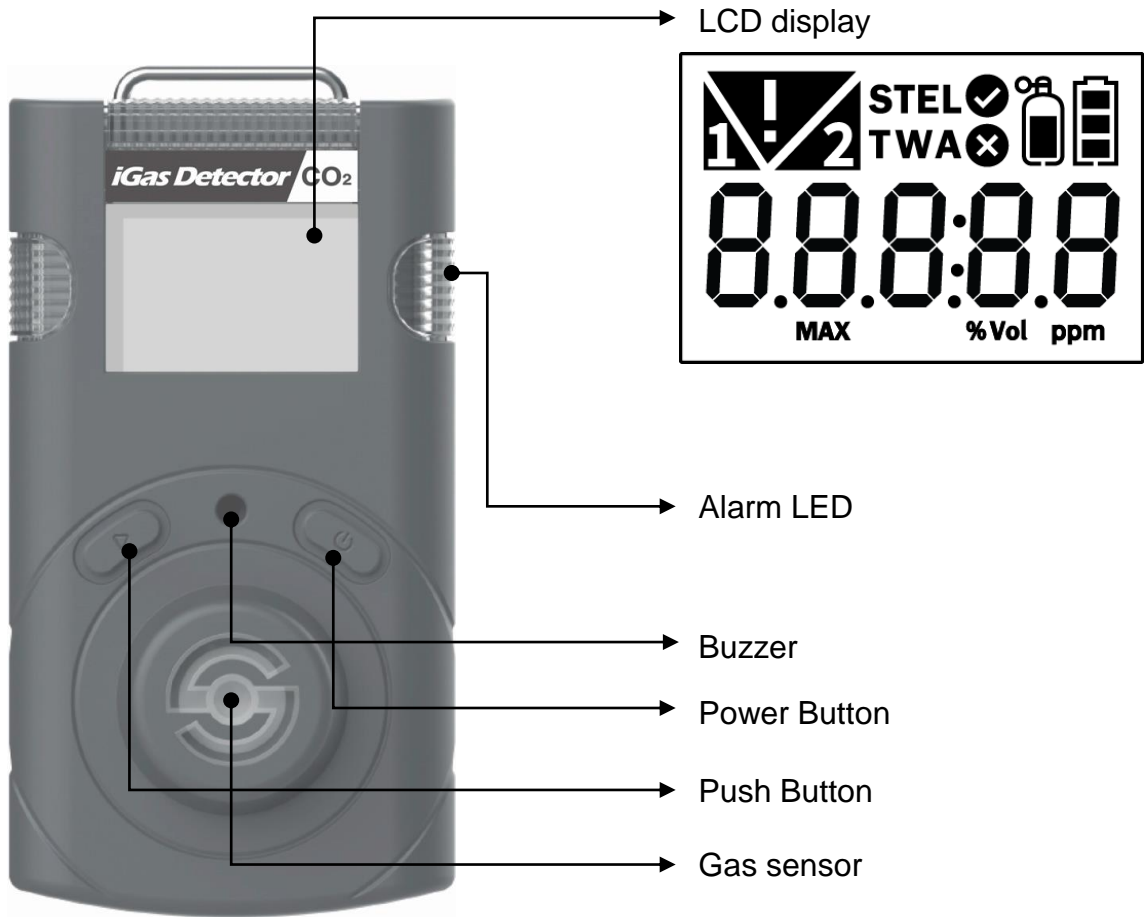

Part Description

	Calibration / Setting Success		Calibration / Setting Failure
%Vol ppm	Measurement Unit		Standard Gas Calibration
	Remaining Battery		Alarm Condition
	1 st Alarm Display		2 nd Alarm Display
MAX	Max Value	STEL TWA	Short Term Exposure Limit Time Weighted Average
	Test Success		Test Fail
	Over Limit		End of Test

2. Activation & Deactivation

1. Move to a fresh air environment, which is free of hazardous gas
2. Press and hold down the power button for approximately 2 seconds until the gas type (CO2) is displayed.
3. Upon activation, gas type(CO2), firmware version, and display appears, and the detector performs the self diagnostic test for 10 seconds.
4. After self test is successful, the detector countdown is displayed for 10 seconds.
5. Allow the detector to stabilize for 90 seconds until warm up message(---) is no longer displayed.
6. The detector displays current CO2 concentration.

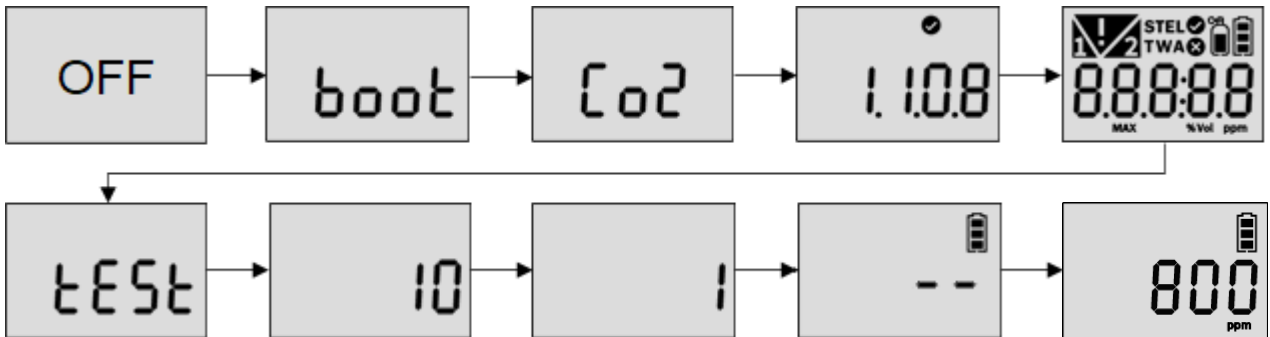

If the stabilization is failed, Error mark is displayed and measuring mode will not be entered. In this case, contact authorized resellers or SENKO service center at 82-31-492-0445 for repair or return.

Err marks

Err-1	Initial setting error
Err-2	Sensor error
Err-3	Memory error
L-bat	Low battery

2.1. Bump test

1. Before daily use, users are required to perform bump test to see a sensor responds to a CO2 gas.
2. To perform the bump test, follow the below steps.
 - Prepare a CO2 gas over low and high alarm.
 - Press and hold the pushbutton and power button for three seconds in the measurement mode. Press the pushbutton until "TEST" is displayed and press the power button 2sec to enter the mode.
 - Press the pushbutton until "BTS" is displayed and press the power button to activate it.
 - After pressing the power button, apply a CO2 gas over low and first alarm and the 30 seconds count down is displayed.
 - Once the test is passed, "SUC"(V) mark displayed. If it is failed, "FA"*(X) mark displayed, then "BTS" will flash on the screen until the bump test is successful.

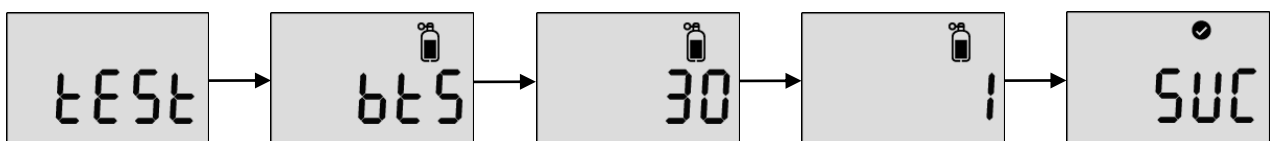

3. Mode









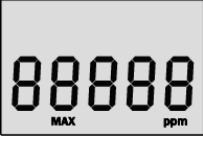

3.1. Measuring mode

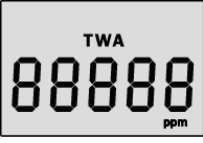
When activated, gas concentration is displayed in measuring mode

3.2. Display mode

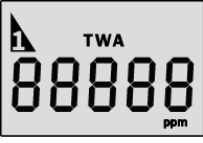
In the measuring mode, by pressing pushbutton, the following ICONs will appear in order. Max value -> STEL value -> TWA value -> 1st alarm setpoint -> 2nd alarm setpoint -> STEL alarm setpoint -> TWA alarm setpoint -> Firmware version -> Calibration concentration -> Calibration interval remaining date -> Bump test interval remaining date

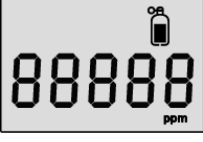
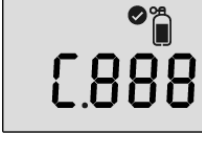
- To move to the next menu, press the pushbutton.
- At the last step, press pushbutton or do not push any button for 10 seconds, the device will return to the Measuring Mode.

	Max Value		Measured STEL value
	Measured TWA value		Low Alarm Value Setting
	High Alarm Value Setting		STEL Alarm Value Setting
	TWA Alarm Value Setting		Firmware version
	Calibration Concentration		Calibration interval remaining date
	Bump test interval remaining date		

3. Mode

3.3. Menu Tree

⏻ 2 sec Power and Enter Button

▷ Push Button

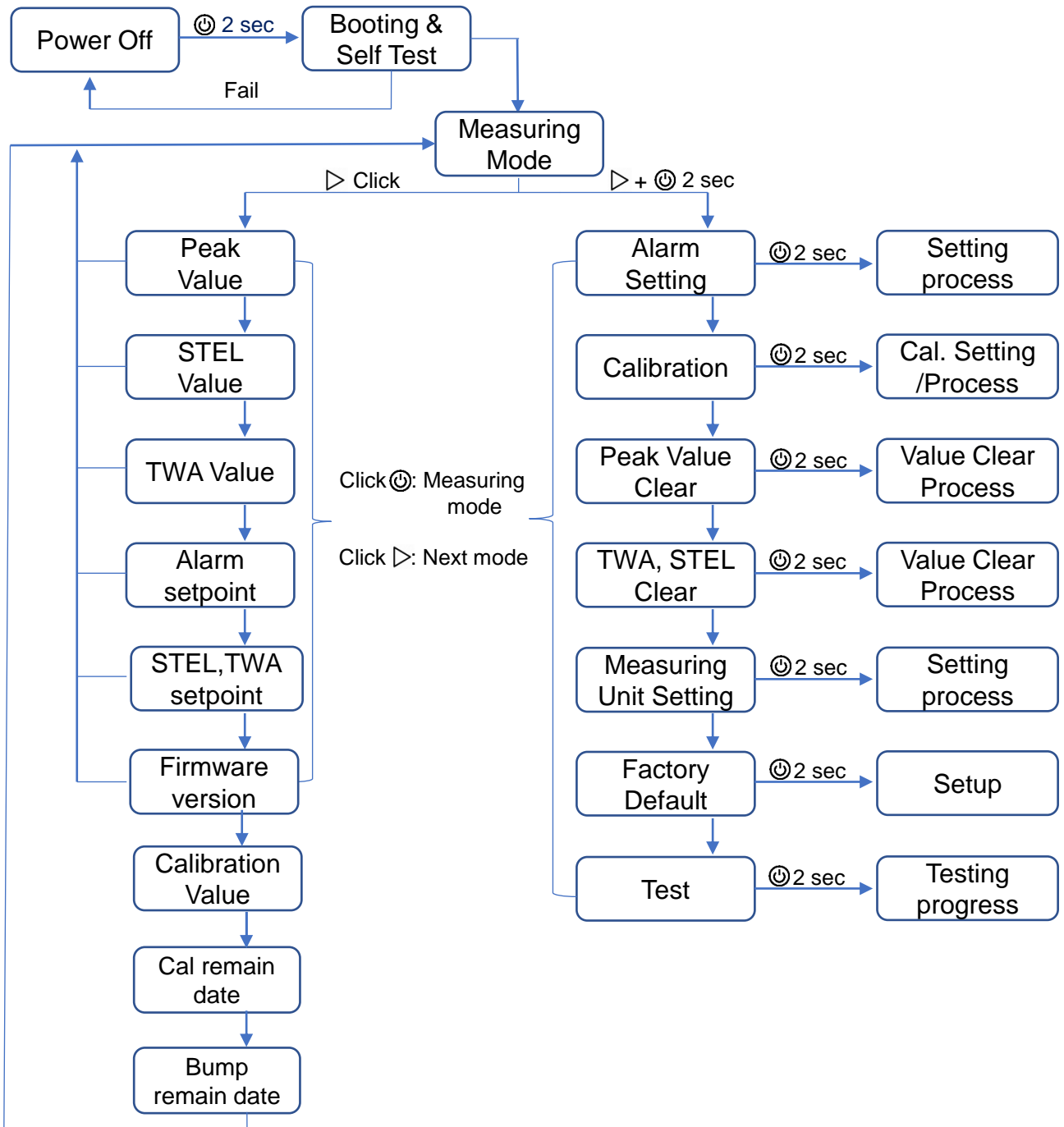

CAUTION







- Clicking the Key button (⏻) during the any mode, will automatically return to the Measuring Mode. To enter to the mode, click and hold the Key Button (⏻) for 2 seconds.

4. Setting Mode

In the setting mode, users can adjust setpoints, perform calibration, and reset previous values.



1. To enter the setting mode, press and hold the pushbutton & power button simultaneously for three seconds. The following menu ALr → CAL → CLr MAX → CLr STEL, TWA → Unit → Init → Test is displayed.
2. To move the next menu, press the pushbutton.
3. To enter the menu, press and hold down the power button.

Setting Mode Symbols

Setting	Submenu	LCD	Action
ALr	1 st Alarm 2 nd Alarm		1 st alarm concentration setting 2 nd alarm concentration setting
CAL	ZERO(N2) SPAN(CO2)		Zero(N2) calibration Span(CO2) calibration
CLr MAX	-		Delete maximum alarm Concentration
CLr STEL, TWA	-		Delete STEL and TWA Concentration
Unit	%vol / ppm		Concentration unit conversion
Init	-		Reset
Test	Self Bts		Self-test Bump test

4. Setting Mode

4.1.1. Alarm Activation

When the gas concentration exceeds alarm set points,  or  will be displayed and the device will vibrate, flash (LED), and beep. To remove alarms, move to a clean air location. When a gas concentration is decreased below the alarm setpoints, alarm will stop.



Low Alarm

- Audible Alarm: 3 beeps per seconds
- LED: 3 flashes per seconds
- Vibration: 1 vibration per second

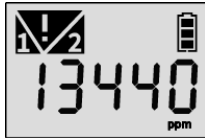
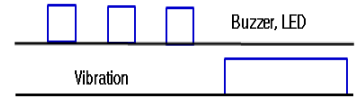

High Alarm

- Audible Alarm: 4 beeps per seconds
- LED: 4 flashes per seconds
- Vibration: 1 vibration per second

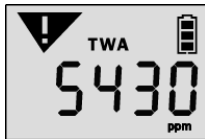
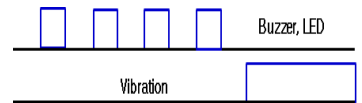

TWA and STEL Alarm

- Audible Alarm: 4 beeps per seconds
- LED: 4 flashes per seconds
- Vibration: 1 vibration per second

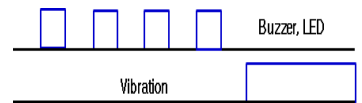

4.1.2. Adjust alarm setpoints



Adjust alarm setpoints

- To enter the setting mode, press and hold the pushbutton and power button simultaneously for two seconds.
- In the alarm setting icon, press and hold down the power button for 2 seconds.



- Press the pushbutton to change the alarm setpoints.
- Press the power button to save the value and move to the next step.

CAUTION

- Ensure that the high alarm setpoint must be greater than low alarm setpoint. Before the alarm adjustment, check with your safety manager or dealer authorized by SENKO. Alarm setpoints may vary by a country or company policy. Unless specified in your company's safety instruction, use the preset alarm setpoints.
- Ensure Standard Factory alarm set points vary depending on countries, states, and companies.
- Before changing alarm setpoints, ensure the alarm set points follow your local guidelines.
- For the safety, users are not allowed to set the 1st alarm value to zero. When attempting to set 1st alarm to zero, the value changes to 400ppm.

4.1.3. Data Log

1. The detector stores the last 30 event logs. If the data is filled, the new log event overwrites the oldest log events.
2. The data log is stored at every 1minute interval, and it stores about 64,000 data logs.
3. Data logs consisting of event log, bump, calibration are stored at 1minute interval.
4. To transfer event logs and data log to a computer, follow below steps.
 - Install the recent iGas detector USB link software.
 - Connect the detector with a computer via a USB-C cable.

*Refer to the more information in the PC program description part.

4. Setting Mode

4.2. Calibration

CAUTION

- Initial calibration is performed on all devices prior to shipment.
- The detector has the zero calibration(N2) and span calibration(CO2)
- Depending on use, a frequency of calibration should be adjusted. For instance, if you use the device daily, weekly or monthly calibration may need to be performed, while the device is used a few times a year, monthly or quarterly calibration may be required. Before calibration, check with your safety managers to ensure calibration accessibility.
- Before calibration, move to a fresh air, which is free of toxic and combustible gases.
- If calibration fails, perform re-calibration again. If the repeated calibration continues to fail, contact authorized safety managers or distributors.

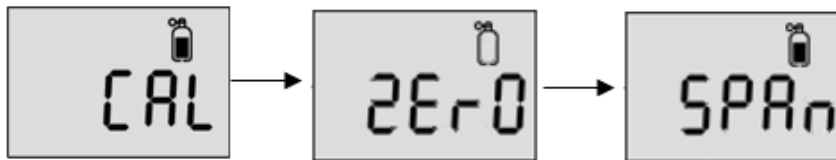

Calibration Gas

Gas Type	Zero(N ₂)	Span(CO ₂)
Concentration	99.99%vol	20,000ppm, 2%vol

① Zero(N₂) Calibration

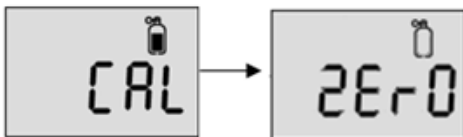

1. In the "CAL" mode, press the pushbutton to move to the "ZERO(N₂)" calibration.
2. Plug the calibration cap to the detector and connect the calibration cylinder with N₂ (99.9%vol)
3. Press the power button and release the N₂ gas.
4. After 90 seconds, when N₂ calibration is successful, success message(V) appears. But, If N₂ calibration is failed, FAIL message(X) appears, and then "Cal" will flash on the screen until the calibration is successful.

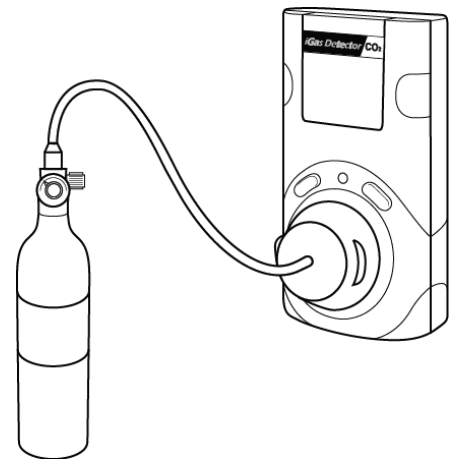

CAUTION

- Use the regulator with a flow rate of 0.2LPM(Liters per minute) of a gas cylinder.

4. Setting Mode

② Span Calibration



1. In the calibration mode, press the pushbutton to move to span calibration.
2. Plug the calibration cap to the detector and connect the calibration cylinder with CO₂ (20,000ppm)
3. Press the power button and release CO₂ gas.
4. After 90 seconds, when the calibration is successful, success message(V) appears. If CO₂ calibration fails, fail message(X) appears, and then "Cal" will flash on the screen until the calibration is successful.

CAUTION

- Do not change the calibration concentration unless dealers or safety managers authorized by SENKO give the permission to change to another calibration concentration.
- Use the regulator with a flow rate of 0.2LPM(Liters per minute) of a gas cylinder.

4.3. Clear max

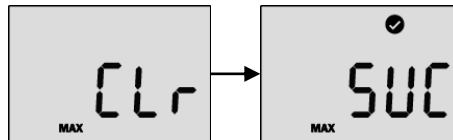

To delete the measured peak concentration in the detector, follow below steps.

1. Press the pushbutton & power button simultaneously and the pushbutton until Clr(max) is displayed.
2. Press the power button to clear the peak value.
3. After the successful activation, SUC (V) mark is displayed. If it fails, FA (X) mark is displayed.

4. Setting Mode

4.4. Clear STEL and TWA

To delete the measured STEL and TWA value in the detector, follow below steps

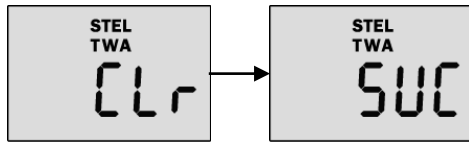

1. Press the pushbutton until Clr(STEL & TWA) is displayed.
2. Press the power button to delete the TWA and STEL value
3. After the successful activation, SUC with V mark is displayed.

4.5. Adjust Unit

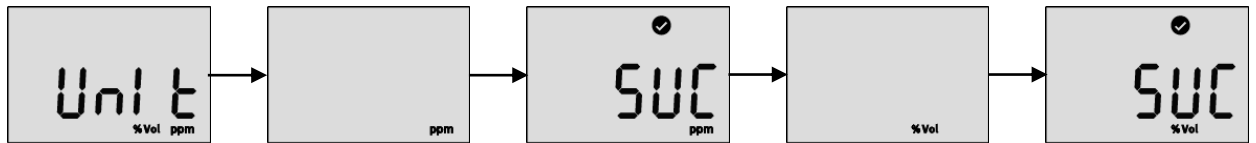

To change the unit(PPM or Vol) in the detector, follow below steps

1. Press the pushbutton until Unit is displayed and power button to enter the mode.
2. Press the pushbutton to select a unit (ppm or %vol) and power button to save it.
3. After the successful activation, SUC(V) mark is displayed. If it fails, FA(X) mark is displayed.

4.6. Factory Reset

To restore the factory setting, please follow below steps.

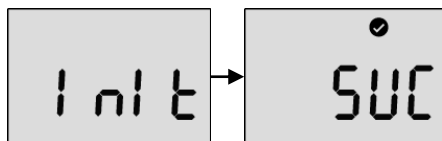

1. Press the pushbutton until "Initiate" is displayed.
2. Press the power button to apply it.
3. After the successful activation, SUC(V) mark is displayed. If it fails, FA(X) mark is displayed.

4.7. Self Test

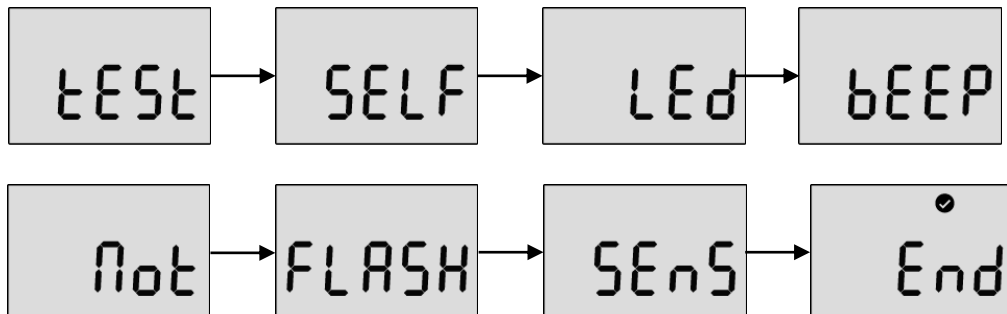

To perform the self diagnostic test, follow below steps.

1. Press the pushbutton until Test is displayed
2. Press the power button for three seconds. In the "SELF" display, press the power button for three seconds to activate the self test. While it's activated, the detector will test LED, beeping, vibration, flash memory, and sensor. After the successful test, V mark is displayed. If the test fails, FA with X mark is displayed.
3. If the self test fails, the Error message appears.

5. Software Manager

5.1. Software Overview

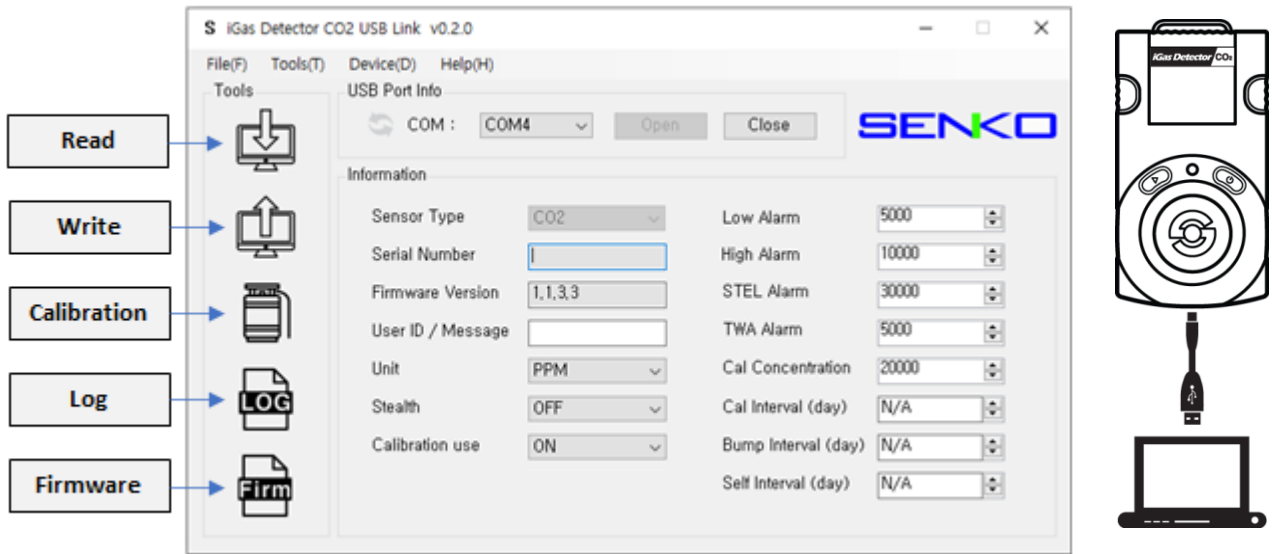

- **Sensor Type** – The current sensor type in the device (CO₂, cannot be changed)
- **Serial Number** – iGas Detector CO₂ serial number
- **Firmware Version** – Current firmware version of the unit (can change by upgrading)
- **User ID/Message** - The User ID can be used to add a usage message
- **Unit** – Adjust measuring unit by PPM or %vol
- **Stealth** – Disable the alarm, buzzer, and LED for a special occasion
- **Calibration Use** – Disable / Enable the calibration access for a special occasion
- **Low Alarm & High Alarm** – The 1st and 2nd alarm set points (Min/Max: 400ppm (0.04%vol) ~ 49,999ppm (5%vol))
- **STEL Alarm & TWA Alarm** – Short Term Exposure Limit and Time Weighted Average level of concentration of CO₂ (Min/Max: 400ppm (0.04%vol) ~ 49,999ppm (5%vol))
- **Gas Concentration** – This allows a user to enter/amend correct concentration of the gas cylinder (Min/Max: 400ppm (0.04%vol) ~ 49,999ppm (5%vol))
- **Calibration Interval (day)** – The calibration reminder informs every fixed day (can adjust 0 (n/a) ~ 365)
- **Bump Interval (Days)** – The Bump test reminder informs every fixed day (can adjust 0 (n/a) ~ 365)
- **Self Interval (Days)** – The Self test reminder informs every fixed day (can adjust 0 (n/a) ~ 365) *Default is N/A

Note:

- When the software is opened, the fields are grayed out and before it can be used, the “OPEN” button must be clicked.
- Without clicking the “Write” button, configured and customized settings will not be applied and neither be saved.
- If the USB connection is successful, the “Success” icon appears. If the connection fails, reconnect the USB cable or check the device manager to see the connection status.

5. Software Manager

5.1.1. Read

The “Read” button (upper-left side first icon) allows a user to retrieve the stored data.

5.1.2. Write

The “Write” button (upper-left side second icon) has one of the most important role in this software interface. Because every single and each configured or customized settings will be saved by clicking “Write” button. When a user configures the instrument’s settings, “Write” button will be clicked and message will pop-up. Click “Yes”.

5.1.3. Calibration

To perform the calibration using software, follow the below:

1. Connect the unit to the PC using instrument’s USB
2. Plug the calibration cap and connect with N2 or CO2 gas cylinder.
3. Open the software and click “Calibration” (middle-left side icon) and wizard will come up
4. Choose the calibration gas type and click “Start” with releasing the cylinder valve.
5. The zero(N2) and span(CO2) calibration takes 90 seconds.

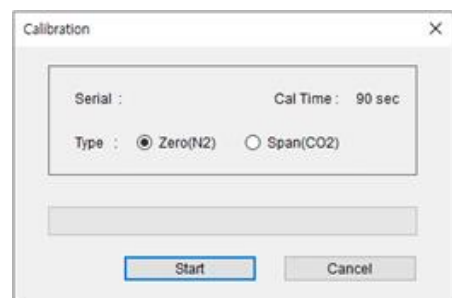

5.1.4. Log

All recent 30 logs will be stored in the device and will be automatically erases one by one from the earliest logs when new event occurs. There are two types of event logs, “Event Log” and “Event + Data log” are available to download. Choose the log and click “Download” button. The log files will be downloaded and created by unit’s Serial number and will be in “.csv” format. However, clicking “Erase” button will clean all the logs from the storage of device and cannot be recovered.

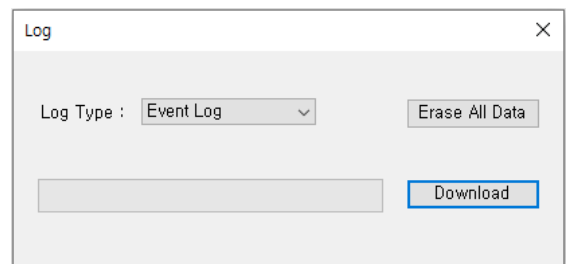

5.1.5. Upgrade (Firmware)

To upgrade the latest firmware version of iGas Detector CO₂, follow the below:

1. Click “Browse” button and navigate to the firmware location
2. Choose the firmware and click the “Open” button
3. Click “Write” to begin upgrading process
4. When upgrade is finished, power off the device and turn it on
5. The “F-UP” → “boot” message will come up and upgrade is complete

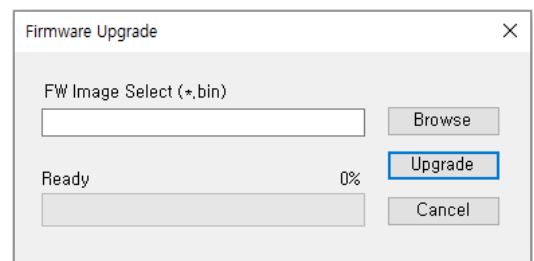

Note:

- Pressing “Cancel” button during the upgrading process will cancel and close the Firmware Upgrade Wizard.

5. Software Manager

5.2. Window menu

5.2.1. Menu – File

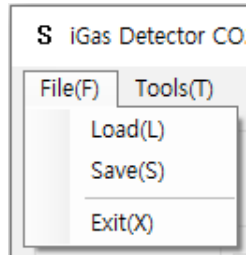

- **Load(L)** – Load the installed settings
- **Save(S)** – Save the current settings
- **Exit(X)** – Finish the work and end the program (close the tap)

5.2.2. Menu – Tools

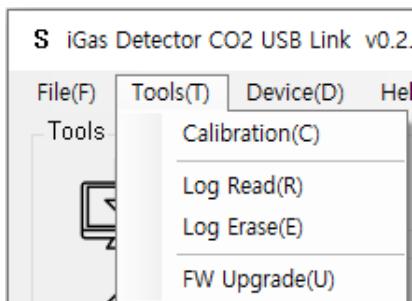

- **Calibration(C)** – Open the calibration window to start calibration process
- **Log Read(R)** – Retrieve and save the log events
- **Log Erase(E)** – Clean all the logs from the storage (erased logs cannot be recovered)
- **FW Upgrade(U)** – Open the firmware upgrade window to start upgrading process

5.2.3. Menu – Device

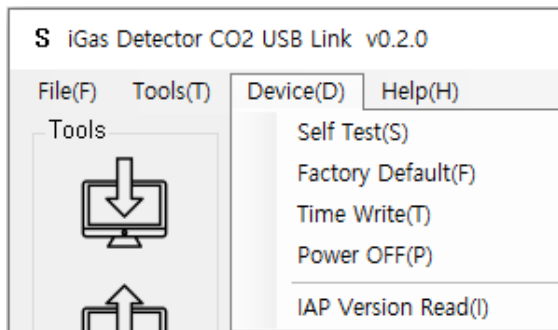

- **Self Test(S)** – Automatic self diagnose of the unit
Test order: LED → Beep → Motor → Flash → Sensor → End
- **Factory Default(F)** – Reset original settings and specifications
- **Time Write(T)** – To set a time by user location (see 5.2.3.1.)
- **Power OFF(P)** – Turn off the device
- **IAP Version Read(I)**

5.2.3.1. Menu – Device

- **Time Write** – The initial time is present at the factory in South Korea, so either apply the current PC time or adjust a time manually by clicking the calendar button, and press “Time Write”.
- **Dev Time Read** – To see a device time set on your device
- **PC Time Read** – To see a PC time

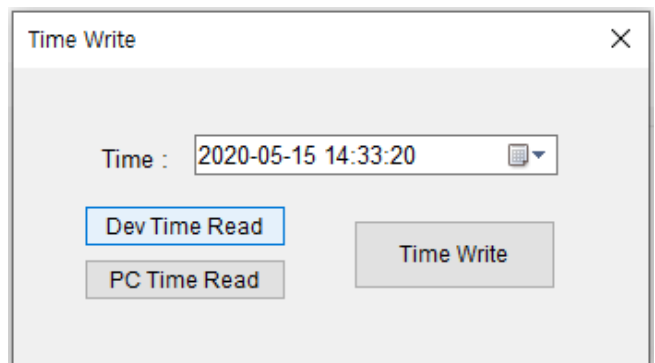

6. Maintenance

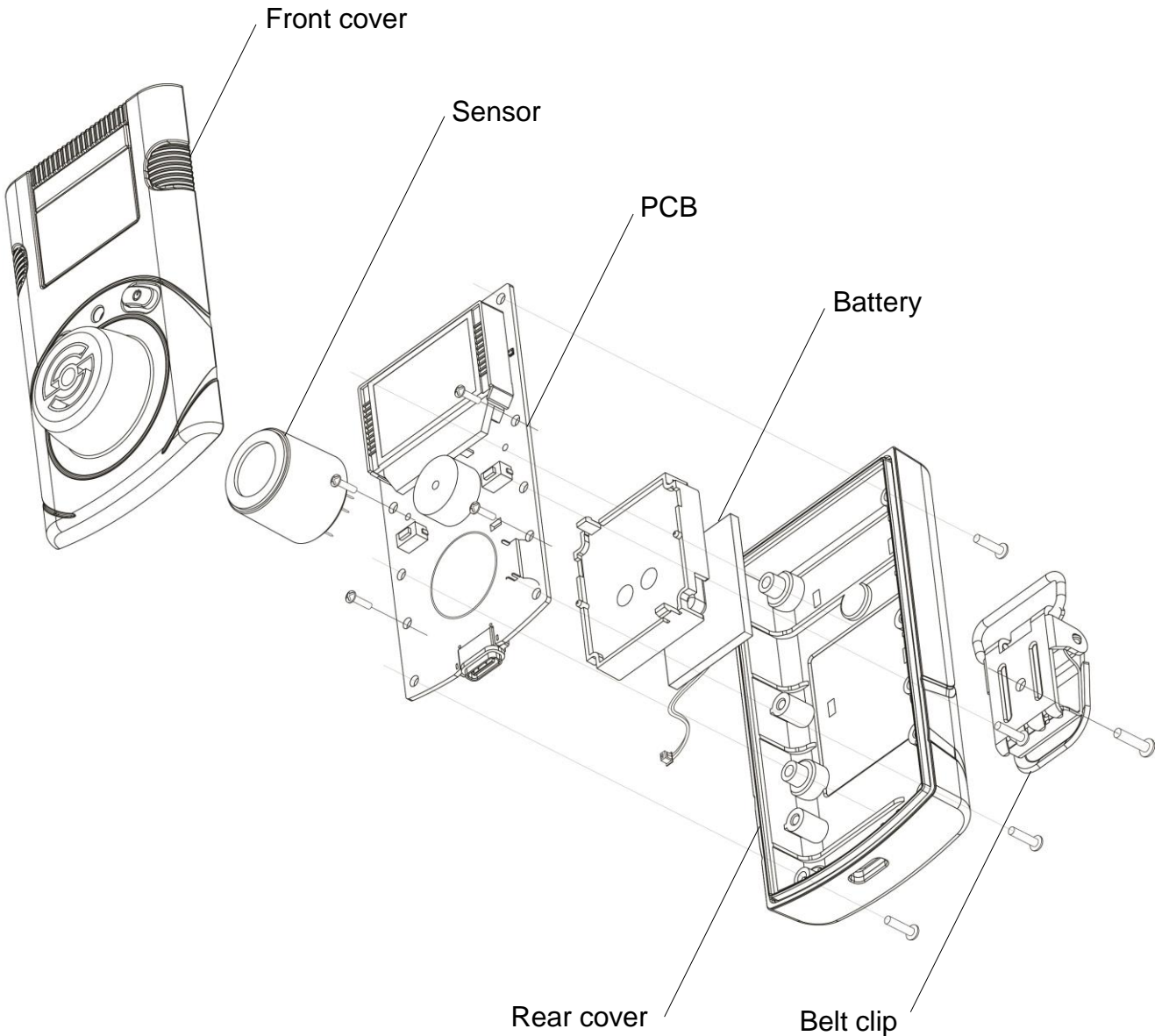

CAUTION

- Before disassembling the detector, power it off.
- It is absolutely prohibited to replace battery at potential explosion or dangerous regions. Replace the battery in a clean environment, which has no hazardous gases.
- Replacement of components can invalidate the intrinsic safety function. Replacing the sensor and battery should be performed by authorized sellers, agents, distributors, or safety managers.
- The sensors published by SENKO should be used for replacement.
Product: Rechargeable Li-ion(polymer) power supply unit (500mAh)
- Service task is limited to only for sensors & battery replacement. After the sensor replacement, recommend to perform the standard calibration with CO₂.

6. Maintenance

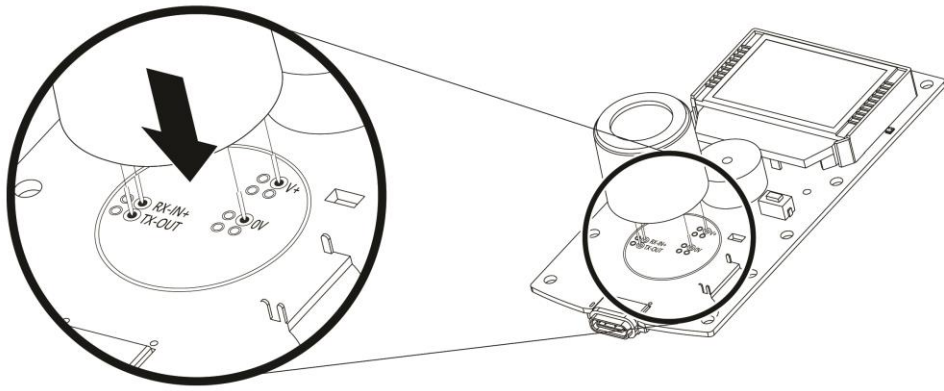

6.1. Sensor Replacement

1. Move to a fresh air environment and power off the detector.
2. Remove the back case by unscrewing the 6 screws.
3. Remove the 2 screws on the PCB Board.
4. Carefully replace with the new sensor provided by the authorized dealers or SENKO. Ensure the sensor pins are matched with the above image and the sensor is aligned with the PCB board.
5. Assemble the detector and turn on the detector.
6. After assembling, perform Zero(N₂, 99.9%vol) calibration, and Span(CO₂) calibration. Before use, stabilize the detector for 3 minutes.

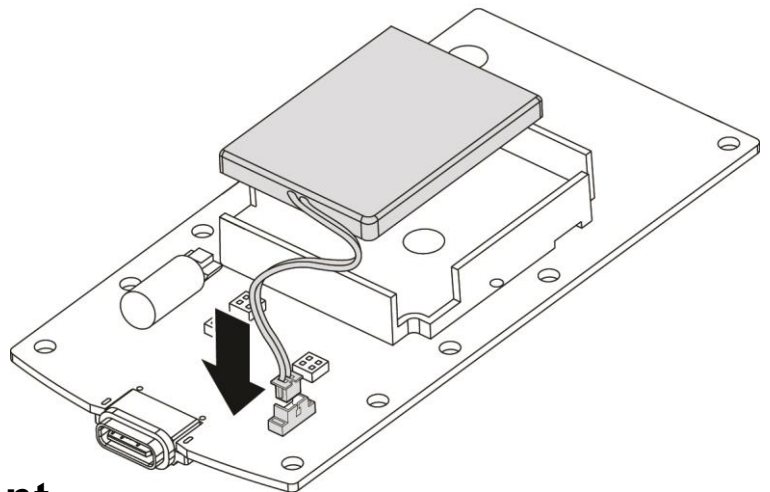

6.2. Battery Replacement

1. Move to a fresh air environment and power off the detector.
2. Remove the back case by unscrewing the 6 screws.
3. Remove the 2 screws on the PCB Board.
4. Carefully unplug the battery from the PCB board.
5. Place the new battery in the battery protection case.
Battery Specification: Rechargeable Li-ion(polymer) power supply unit (500mAh)
6. Assemble the detector and turn on the detector.
7. Before use, stabilize the detector for 3 minutes.

7. Specification

Model	iGas Detector CO ₂
Sensor Type	NDIR
Measurement	Diffusion type
Display	LCD display
Audible	90dB at 10cm
Warning Lamp	Red Flashing LEDs
Vibration	Vibration Alarm
Battery	Rechargeable Li-ion(polymer) power supply unit (500mAh)
Charging Time	100 minutes from empty battery to fully charge based on power off state and charging with adaptor
Temperature	-20°C ~ +50°C
Humidity	5%~95% RH (Non-condensing)
Case	Rubber Enclosure
Accessories	Calibration Cap, Charge Cable(USB C-Type) and adaptor
Calibration Flow Rate	Flow rate: 0.2LPM (N ₂ , CO ₂)
Size &Weight	Size: 54(W) x 99.5(H) x 38.8(D)mm, Weight: 135g
Operating Life	14 days(Expected) (in measuring mode without alarm)
Event Log	Recent 30 alarms
Approval	EMC directive(2014/30/EU)

Sensor Specification

Gas	Measuring range	Low Alarm	High Alarm	Resolution
CO ₂	0~5.0%vol 0~50000ppm	0.5%vol 5000ppm	1%vol 10000ppm	0.01%vol 100ppm

8. Battery Charging

To charge the battery,

- Connect the USB-C type cable with the charging port at bottom of the device.
- Connect the USB port with a provided adaptor (5V, 1.2A)
- While charging, the backlight illuminates.
- After the full charging, the back light turns off with full battery symbol.
- In the low battery, the alarm is activated every three minutes.

Note:

- The device can still charge by connecting to a PC and the purpose of connection is not for charging but for linking the PC program.

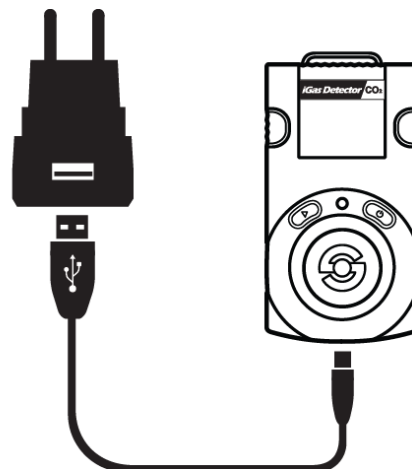

Limited Warranty

SENKO warrants this product to be free of defects in workmanship and materials-under normal use and service for two years from the date of purchase from the manufacturer or from the product's authorized reseller.

The manufacturer is not liable (under this warranty) if its testing and examination disclose that the alleged defect in the product does not exist or was caused by the purchaser's (or any third party's) misuse, neglect, or improper installation, testing, or calibrations. Any unauthorized attempt to repair or modify the product, or any other cause of damage beyond the range of the intended use, including damage by fire, lightening, water damage or other hazard, voids liability of the manufacturer.

In the event that a product should fail to perform up to manufacturer specifications during the applicable warranty period, please contact the product's authorized reseller or SENKO service center at +82-31-492-0445 to repair/return information.



iGas Detector CO₂ User's Manual

© Copyright 2004 by SENKO CO., LTD All Right Reserved.

Technical Support

If you need more information or require technical support, please contact Sales team.

Tel. +82-31-492-0445

Fax. +82-31-492-0446

E-mail: sales@senko.co.kr

Senko Co., Ltd.

445, Doksanseong-ro, Osan-si,

Gyeonggi-do, 18111, South Korea